











172 - FUR CHANNEL KIT

TECH MANUAL

13305	 32" Division Bar Channel (2 per Car)	Location A
13306	 24" x 3/8" Fur Strip Exterior (2 per Car)	B
13346	 19 1/2" x 1 5/8" Moleskin Liner(2 per car)	C
13307	 26" x 3/8" Bent Fur Strip LH Interior (1 per car)	D
13309	 26" x 3/8" Bent Fur Strip RH Interior (1 per car)	E
13308	 24 3/4" x 3/8" Bent Fur Strip LH Exterior (1 per car)	F
13310	 24 3/4" x 3/8" Bent Fur Strip RH Exterior (1 per car)	G
13349	 Screw Kit (1 per car)	

NOTE: Not all Hardtops used the 13306 Fur Strips (B in Diagram) if no metal extension has been attached to the Door Belt Moulding (15671 - DS , 15672 - PS or 16515 - Pair). Those Hardtop use an Inner Roller Guide (14790) and Outer Roller Guide (2082).

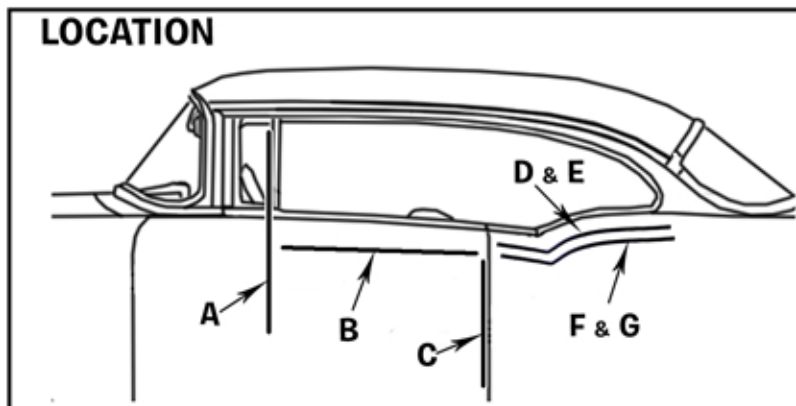

2DR HARDTOP

Danchuk Tech Manual 55	
Section 15	Sheet 2.05